

Petrochemical Catalogue



- Skin Type Thermocouples
- Multipoint Thermocouples
- FCCU Thermocouples
- SRU Thermocouples
- Bearing RTD
- Vibration Proof RTD

- Instrumentation & Control Cables
- Mineral Insulated Cables
- Furnaces
- Temperature Calibration Equipments
- Temperature & Pressure Gauges
- Calibration Services

ABOUT THE COMPANY

TEMPSENS Instruments (I) Pvt. Ltd is a part of Pyrotech group which was established by four technocrats in 1976 at Udaipur, with its first product as Thermocouples and RTDs.

Today Tempsens is one of the world's largest solution provider for thermal engineering products - ie. Temperature Sensors, Infrared Pyrometers, Heaters and Cables. The headquarters are based in India, and manufacturing units in Germany and Indonesia.

Tempsens is an ISO 9001:2008, ISO 14001, OHSAS 18001 certified company with NABL Accredited Laboratories.

The company is involved into manufacturing of Thermocouples, RTDs, Thermowells, Cables, Non contact Pyrometers, Heaters and Calibration Equipments etc. with covered area of 2,70,000 Sq. Ft.

Tempsens is proud of its technical solution, quick delivery, high technical standards and outstanding quality which have been appreciated and valued by its customers worldwide.

Tempsens exports to more than 70 countries.

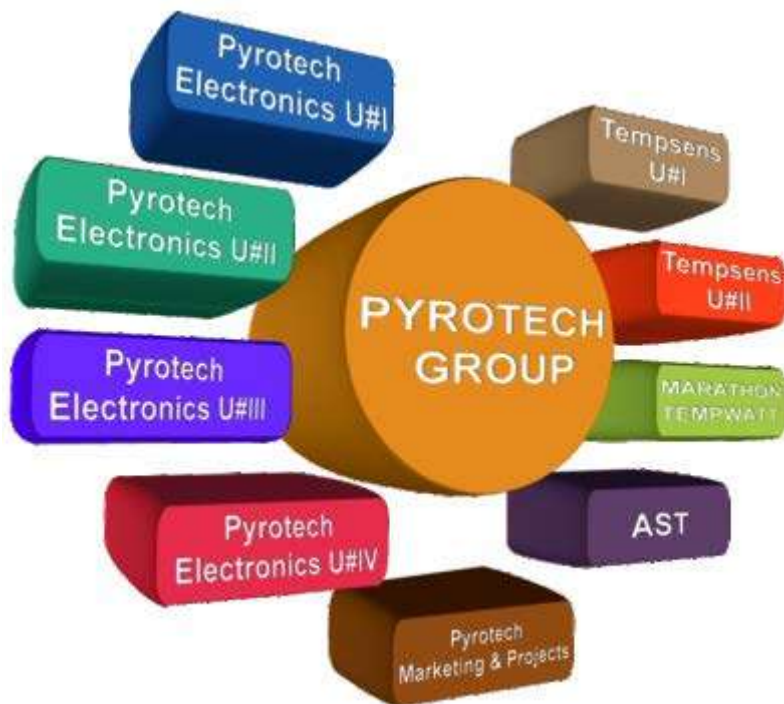

Tempsens success is driven by its people and their unrelenting focus on delivering results the right way - by operating responsibly, executing with excellence, applying innovative technologies and capturing new opportunities for profitable growth.



Tempsens Instruments U# I



Tempsens Instruments U# II



**AST Plant - First Floor
Marathon Plant - Ground Floor**



**Tempsens Instruments U# II
Cable Plant**



**Tempsens Instruments GmbH
- Germany**



**Pt. Tempsens Asia Jaya
- Indonesia**

FACILITIES

WELDING AND BRAZING

- Laser Welding Machines
- Programmable Micro Plasma Welding Machines
- TIG Welding Machines with Pulse Modulation And Rotary Positioner
- Induction Brazing Machines
- Resistance Welding Machines
- Brazing Sets (Oxy-Acetative)
- Deep Penetration Welding Machines



MACHINING

- CNC Turning Centers
- Turn Mill Centers
- VMC Machines
- Deep Hole Drilling Machines upto 1500mm Drilling Capacity
- Milling Centers
- Manual Lathe Machines
- Cutting Machines



HEATER PLANT

- Swaging Machines
- Laser Marking Machines
- Laser Cutting Machine
- Bright Annealing Machine
- Engraving Machines
- Coil Making Machines
- High Frequency Annealing Machines
- MgO Filling Towers
- Rolling Machine & Skinning Machines
- Vacuum Presses



CABLE PLANT MACHINERY

- FEP/PFA Extrusion Lines
- PVC/XLPE Extrusion Lines
- Silicon Extrusion Line
- Armoring Lines
- Laying Lines
- Copper Drawing Plant
- Conductor Stranding Machines
- Braiding Machines - High Speed and Regular
- Rewinding Machines
- Vertical Lapping Machines & Stranding Machines
- Tape Wrapping Machines
- PTFE Extrusion and Tape Roll Down Plant
- Metering Machines
- Buncher Machines
- Spark Tester & Diameter Testers
- Packaging Machines



MI CABLE PLANT

- Draw Bench 50 meters, Horizontal Draw Benches
- Annealing Furnaces
- MI Polishing Machines
- MgO Plant

TESTING AND CALIBRATION

- NABL Accredited Calibration Lab -196°C to 1600°C for Contact and upto 2700°C for Non Contact Sensors
- NABL Accredited Testing Centre for cables & wires.
- Computerized Calibration System
- Fixed Point Cells-TPW, Ga, Sn, Zn, & Al and AC Bridge for Primary Standards
- Digital Radiography Setup for Junction Integrity
- PMI Setup for Chemical Analysis of Alloys
- Pressure Test Setup
- Helium & Nitrogen Leak Detector
- Profile Projector
- Dye Penetration Test Setup for Weld Joints
- Microscopic Junction Check
- Response Time Test, least count 1 msec.
- Ultrasonic Thickness Test
- Giga Ohm Insulation Resistance Testers
- Mechanical checks - lengths, gauges, concentricity checks
- Conductor Resistance Test
- Test for thickness of Insulation and Sheath
- Physical test for Insulation and Outer Sheath
- High Voltage Test Sets
- Flammability Test & Tensile Testers
- Auto Clave Testing



BASICS OF THERMOCOUPLES & RTDs

THERMOCOUPLE

Thermocouples are pairs of dissimilar metal wire joint at one end, which generate a net thermoelectric voltage between the open pair according to temperature difference between the ends.

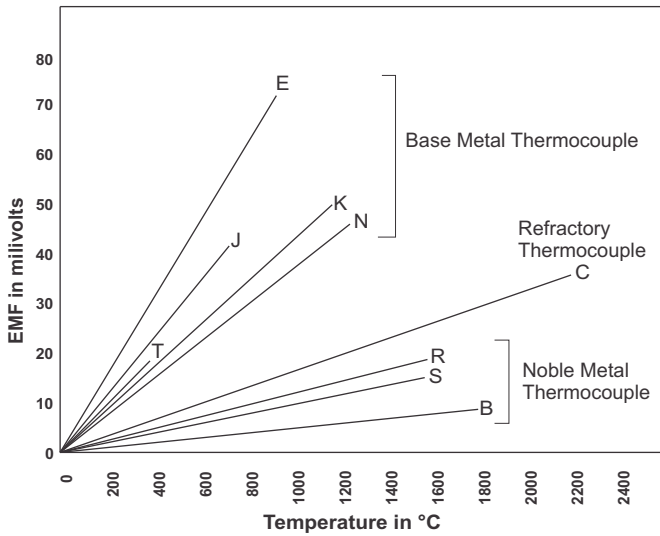

Tolerance Table for Type of Thermocouples

Type of T/C	Material (+ & -)	Temp. Range(°C)	Tolerance Grade	
			Standard	Special
T	Copper & Constantan	-200 to 370°C	±1.0°C or ±0.75%	±0.5°C or ±0.4%
J	Iron & Constantan	0 to 760°C	±2.2°C or ±0.75%	±1.1°C or ±0.4%
E	Chromel & Constantan	-200 to 870°C	±1.7°C or ±0.5%	±1.0°C or ±0.4%
K	Chromel & Alumel	-200 to 1260°C	±2.2°C or ±0.75%	±1.1°C or ±0.4%
N	Nicrosil & Nisil	-200 to 1260°C	±2.2°C or ±0.75%	±1.1°C or ±0.4%
S	90% Platinum/ 10% Rhodium & Platinum	0 to 1450°C	±0.5°C or ±0.25%	±0.6°C or ±0.1%
R	87% Platinum/ 13% Rhodium & Platinum	0 to 1450°C	±0.5°C or ±0.25%	±0.6°C or ±0.1%
B	70% Platinum/ 30% Rhodium & 94% Platinum/ 6% Rhodium	800 to 1700°C	±0.5%	---
C	95% Tungsten/5% Rhenium & 74% Tungsten/26% Rhenium	0 to 2320°C	4.5°C or ±1.0%	---



Thermocouple Insert Construction

RTD

Resistance thermometer use metals that alter their electric resistance when heated.

Platinum is the most commonly used material for industrial RTD. However Copper and Nickel are also used for some applications.

The resistance at 0°C is called R_0 and it is an important parameter to be defined. The most commonly used RTD element is of platinum with resistance of 100 Ω at 0 °C. Thus named as Pt 100.

Platinum RTD are suitable for temperature range -200 to 850°C. Normally Industrial RTD's are used at temperature range upto 400°C.

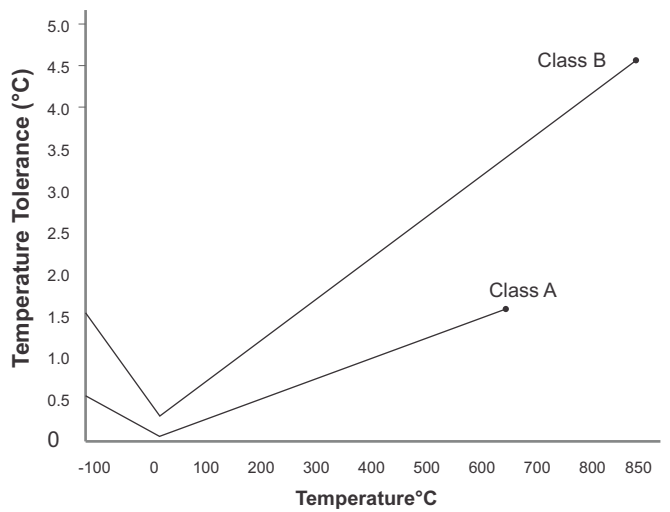

Tolerance Table for Type of RTD(as per IEC 751)

Temperature	Class A (±)	Class B (±)
-200°C	0.55°C	1.3°C
-100°C	0.35°C	0.8°C
0°C	0.15°C	0.3°C
100°C	0.35°C	0.8°C
200°C	0.55°C	1.3°C
300°C	0.75°C	1.8°C
400°C	0.95°C	2.3°C
500°C	1.15°C	2.8°C
600°C	1.35°C	3.3°C
700°C	-	3.8°C
800°C	-	4.3°C
850°C	-	4.6°C



RTD Insert Construction

BASICS OF THERMOCOUPLES & RTDs

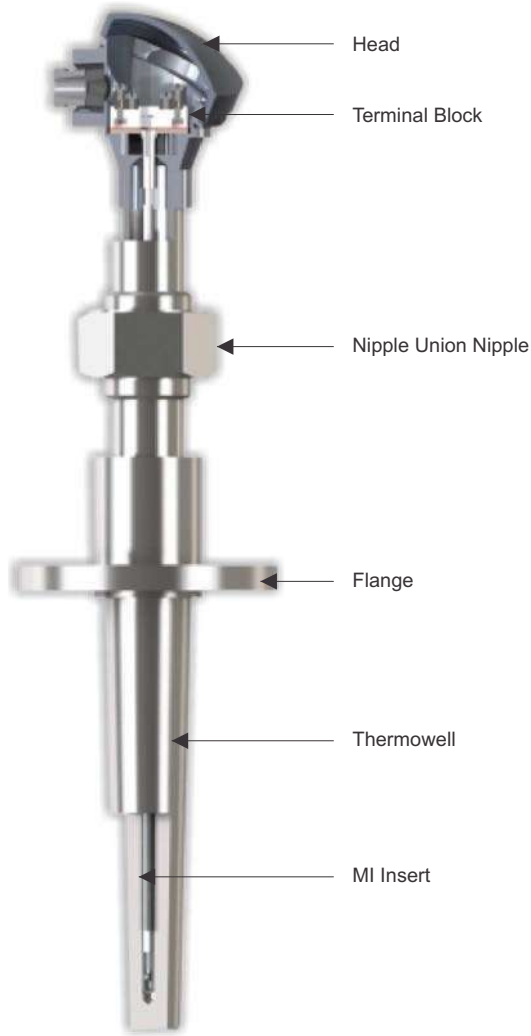

MI Construction

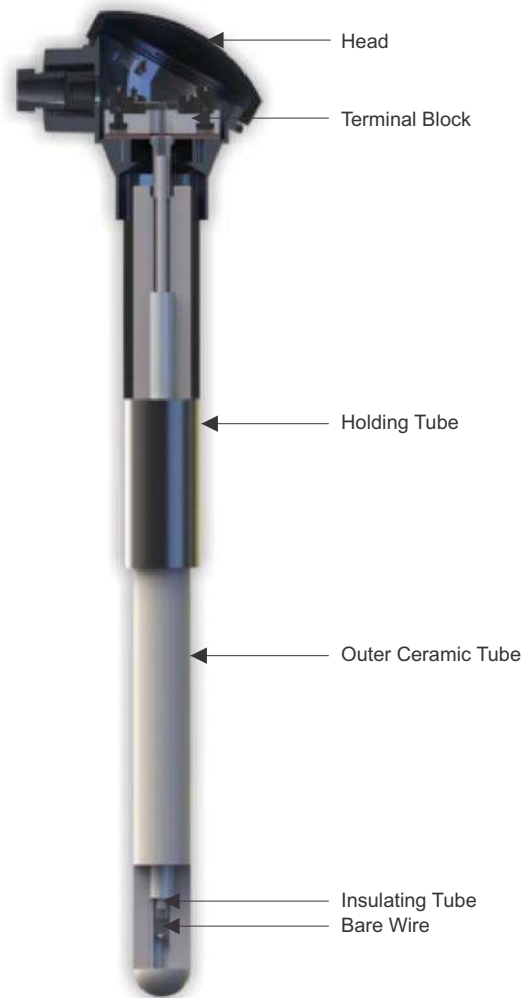

Non MI Construction

Metallic Protection Tubes

Sr. No.	Material	Max./Operating Temp(°C)	Feature
1	304 S.S.	980°C	Common against heat and corrosion.
2	321 S.S.	980°C	Higher corrosion resistance.
3	316 S.S.	980°C	Excellent resistance to corrosives, heat, acids and alkalis.
5	310 S.S.	1,000°C	Good high temperature strength with resistance to oxidation.
6	446 S.S.	1,050°C	Excellent resistance to oxidizing and reducing flames containing sulphur.
7	Inconel 800	1000°C	Excellent to high temperature oxidizing atmosphere and thermal shock.
8	Inconel 600	1,050°C	Excellent resistance at high temperature, Avoid sulphurous atmospheres
9	Platinum	1,650°C	Well suited for use at extremely high temperature specially for molten glass
10	Titanium	Oxi. 250, Red. 1000°C	Superior corrosion resistance in cryogenic temperature.
11	Tantalum	Oxi. 300, Red. 2200°C	Suitable for inert & vacuum applications
12	Molybdenum	Oxi. 400, Red. 2000°C	Suitable for inert, vacuum & reducing applications

Ceramic Protection Tubes

Sr. No.	Material	Max./Operating Temp(°C)	Feature
1	Recrystallised Alumina 99.7% purity (C-799)	1750°C	Good resistance to chemical attack, mechanically strong but avoid severe thermal shock
2	Ceramic 60% Alumina (C-610)	1500°C	Sintered alumina, used in heating furnaces, regenerators etc.
3	Nitride Bonded Silicon Carbide	1500°C	Good resistance, mechanically strong, unsuitable for oxidizing atmosphere but resist fluxes.
4	Silicon Nitride	1350°C	Excellent thermal shock resistance, most suitable for molten aluminium
5	Recrystallised Silicon Carbide	1500°C	Excellent thermal shock resistance
6	Tungsten Carbide	350°C	Good mechanical strength and high abrasion resistance

RETRACTABLE - SKIN TYPE THERMOCOUPLE

Tube Skin Thermocouples provide an efficient means of temperature measurement on the tube surface in Oil & Gas plants as well as Heater Tubes & Boiler tube temperature in Power Plants. Heat shields maybe added which prevent addition of external / ambient temperature on the junction thereby providing a more accurate temperature measurement. Expansion loops or coils are designed to avoid the effect of tube expansion which are subject to thermal growth. Mounting clamps are welded along the pipe for additional support.

Tempsens provide custom build tube skin thermocouples as per the user requirements & drawings. Skin Thermocouple assembly consists of spring loaded thermocouple, magnesium oxide probe (MgO - 99.5% purity), Ex proof connection head, expansion loop and different type weld pad (Knife edge, Fan Type, Welded, Interchangeable & Washer). also include an optional ceramic terminal block or head mounted transmitters.

Specification

Temperature Range : 0°C to +1260°C (depending upon process)

Sheath Diameter : 6, 8.5, 9.5, 10.5, 12.7 (other sizes on request)

Outer Sheath : SS316, SS310, HRS446, Inconel 600 etc.

TC Type : Simplex/Duplex (Grounded/Ungrounded)



Assembly Type

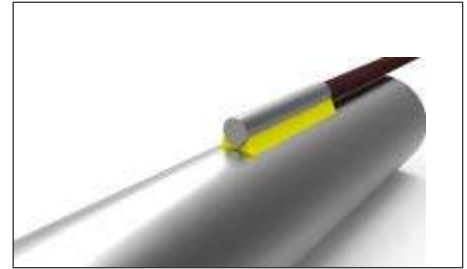

Knife Edge

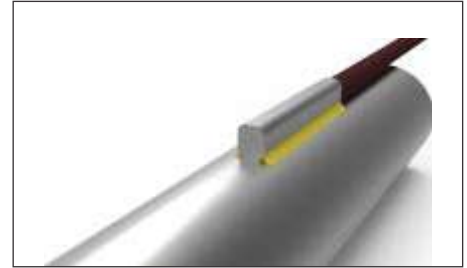

Fan Type

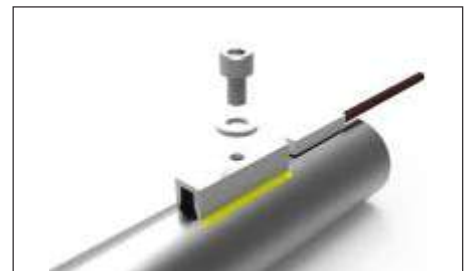

Interchangeable



Weld Pad

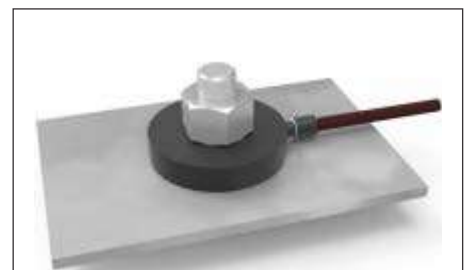

Washer Type

THERMOCOUPLE FOR SULPHUR RECOVERY UNIT (SRU)

The thermocouple junction is isolated from the corrosive and invasive gases by using a constant air purge system across the junction.

AIR purge system is kept at a pressure higher than the internal reactor pressure to avoid the entry of hazardous process gases inside the inner tube as the ceramic tube is the porous one. This is required to avoid the thermocouple oxidation and to get a fair life.

Glass Sealing is done below the terminal block / on the inset top to avoid accident during the breakage of ceramic tube, as it acts as a pressure boundary wall & stop the inner pressure to come out through the head.

Specification

Measuring Range : Ambient to 1500°C (S Type/R Type/ B Type)

Type of Sensor : Simplex, Duplex (Ungrounded)

Standard Sheath Materials : Ceramic KER – 710/C799

Flange Material : Carbon Steel or Stainless Steel

Working Pressure : Upto 10 Bar



MULTIPOINT THERMOCOUPLE

Temperature measurement at different points are possible with Multipoint Thermocouple of various lengths, where multiple sensors can be fixed through a single holding tube or multiple probe individually supported by a single flange.

Custom built multipoint thermocouple can also be designed to withstand extreme working temperatures and pressures.

A suitable junction box is provided as per the ambient condition and area classification(Exproof IIB & IIC) at terminal connections, an extension tube to place the junction box away from the radiated vessel.

Available materials of JB : LM6, SS, MS, CS

Specification

Measuring Range : 0 to 1000°C (depending upon process)

No. of Sensors : As per customer requirement & length up to 40 meters appx.

Standard Sheath Materials : SS316, SS310, Inconel 600 (nickel alloy 600)



Thermocouples Assembly

Applications

- Reactors
- Crackers & Liquefied Gas in Tanks



Tip Assembly



FCCU THERMOCOUPLE

Fluid catalytic cracking (FCC) is one of the most important conversion processes used in petroleum refineries. It is widely used to convert the high-boiling, high-molecular weight hydrocarbon fractions of petroleum crude oils into more valuable gasoline, olefin gases and other products. Cracking of petroleum hydrocarbons was originally done by thermal cracking.

The purpose of Shear Valve is to close the valve manually & to cut the thermocouple probe, if the protection tube fails or get punctured inside the process which in turns will avoid any leakages.

A boron coating minimize the formation of hydrocarbons on the surface of the parent material at a temperature of around 900°C in order to achieve all the desirable properties. An extremely hard coating can be done with a thickness (0.007 to 0.4 mm) and a surface hardness (1200 to 2800 HV) depending on the material type, temperature and process reaction time.

Specification

Measuring Range : Ambient to 1500°C (S Type/R Type/ B Type)

Type of Sensor : Simplex, Duplex (Ungrounded)

Standard Sheath Materials : Ceramic KER – 710/C799

Flange Material : Carbon Steel or Stainless Steel

Working Pressure : Upto 10 Bar

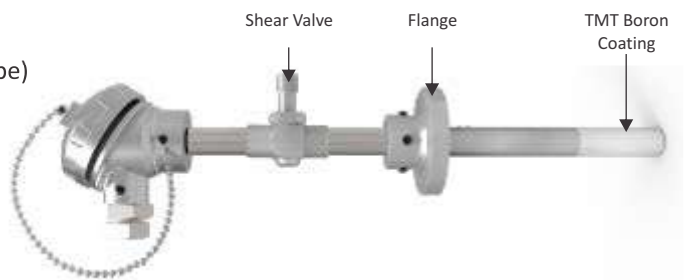

VIBRATION PROOF RTD

Machine vibrations are common in industrial processes which can arise from the vibration of motors, pumps or compressors.

Vibration RTD's are specially designed to withstand such vibrations in the process & for low temperature measurement.

Vibration Range available upto 5G.



BEARING RTD

Area having space limitations but where temperature measurement is also important, there we can use a small size & fast response sensor.

Bearing sensors are manufactured using thin film technology and designed as tip sensitive and vibration resistant.

Measuring Range : -50 to 260°C (-58 to 500°F)

RTD Type : Simplex / Duplex (Ungrounded)

Tip Size : Minimum 3 x 10 MM (as per requirement)

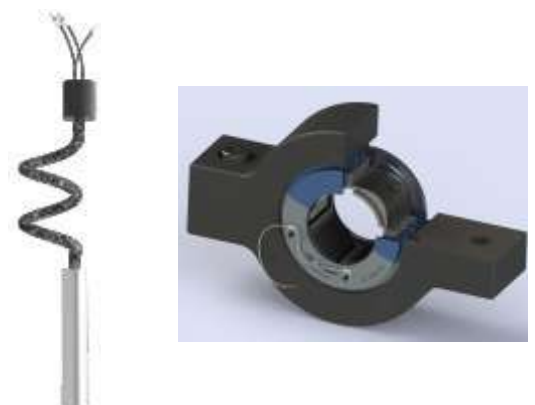

COT THERMOWELL

Erosive environments such as catalyst regeneration require the use of high hardness materials either via coated surface or solid construction. Stellite commonly used as a high hardness metal alloys for thermowell applications in Naphtha Cracker & FCC Unit. Tempsens can provide such thermowells or other similar thermowells to assure maximum service life and optimum performance.

Specifications

Temperature Range : 1000°C

Tip Material : Solid Stellite 6

(Stellite coating is also possible)



High-hardness Material
Solid Barstock Construction



High-hardness Material
Coatings for Thermowells

TANTALUM / TITANIUM SLEEVE THERMOWELL

Temperature measurement is very critical in acidic application, because acid surface contaminants at a rate proportional to pH and temperature.

A temperature sensor was installed in the pickle liquor feed line to monitor the liquid temperature. Due to the high flow rate in the line, time response was crucial to the effectiveness of the measurement. They were using direct immersion thermocouples and were having challenges with both the accuracy of the measurement and the life span of the thermocouple due to acid.

Thermowells can be available in Sleeve type or Barstock Construction.



HELICAL STRAKE THERMOWELL

Helical Strake Thermowell are specially constructed thermowells which have special design features that allows the thermowell to be sustained well inside a fluid flow. Special feature of this thermowell is the helical ridges which are constructed using standard calculations, these helical ridges reduces the vortex formation inside the fluid flow due to the thermowell which reduces the vibrations upto 90% compared to a normal thermowell. The construction of this thermowell is based on the parameters provided in the standard ASME STS- 1.

- ✓ **Thermowell material** : SS 304/310/316, Inconel 600, Monel 400 etc.
- ✓ **Thermowell OD** : min 9.2mm
- ✓ **Thermowell ID** : min 3.2mm
- ✓ **Process Connection** : As per Requirement (Flanged/Threaded/Welded)
- ✓ **Wall Thickness** : min 3mm
- ✓ **Tip Thickness** : min 3mm
- ✓ **Unsupported Length** : 63.5mm - 600mm
- ✓ **Helical Length** : As per Requirement.
- ✓ **Helical Strake height** : 10% OD (Acc. to ASME standard)
- ✓ **Helical Pitch** : 5xOD (Acc. to ASME standard).
- ✓ **No. of Strakes** : 3 Nos. at 120° from each other.
- ✓ **Strake Angle** : 58° (Acc. to ASME standard).
- ✓ **Strake Construction** : Machined/Wire Welded.



GAUGES

TEMPERATURE GAUGES



Sensing Elements	: Bi-metal, Liquid Filled, Gas Filled
Dial Size	: 63, 80, 100, 150, 250 mm
Stem Dia	: 6, 8, 10, 12 mm
Range	: Min. -40°C, Max. 650°C
Accuracy	: Class 1 as per EN13190
Standard	: EN13190/IS13211
Enclosure Protection	: IP-55, IP-65 (Filled)
Connection	: 1/8", 1/4", 3/8", 1/2" BSP/NPT (M/F)
Mounting	: Center Back, Bottom Direct, Every Angle Mounting
Over-Range Protection	: 30% above FSD

Special Feature

- Electric Contact Type Thermometer
- Dual Scale
- External Zero Adjustment
- Gas/Liquid filled with capillary max length upto 30 Mtr
- Dampening Liquid Glycerin/Silicon Oil filled

PRESSURE GAUGES



Sensing Elements	: Bourdon Tube, Sealed Diaphragm, Compact Sealed Diaphragm, Schaffer Diaphragm, Capsule Diaphragm
Dial Size	: 40, 50, 63, 80, 100, 150, 250 mm
Range	: Vacuum, Compound, 0....1Kg/cm ² to 0....2100Kg/cm ²
Accuracy	: ±1% FSD
Over-Range Protection	: 30% above FSD
Standard	: IS 3624, EN837
Enclosure Protection	: IP-55, IP-65 (Filled)
Connection	: 1/8", 1/4", 3/8", 1/2" BSP/NPT (M/F)
Mounting	: Bottom/Back Direct , Bottom Surface, Back Panel, Back Bracket Mounting

Special Pressure Gauges

- Maximum reading pointer Pressure Gauge
- Homogenizer Pressure Gauge
- Mud Pressure Gauge
- Electric Contact Pressure Gauge
- Dampening Liquid Glycerin/Silicon Oil filled



BASICS OF WIRES & CABLES

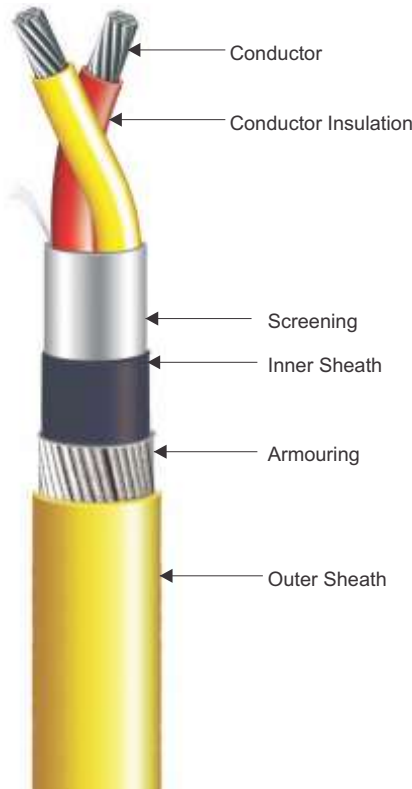

INSULATION

Insulation refers to the layer of plastic, polymer or high temperature compound that is applied directly over the conductor. Tempsens provide variety of insulations along with wide temperature range from -260°C to 1200°C.

Insulation Type

Temperature range for various insulations are listed below :

Alumina Fibre	-73°C	1200°C
Ceramic Fibre/Silica	-73°C	800°C
Fiber Glass	-73°C	550°C
Polyamide	-267°C	310°C
PTFE/PFA	-267°C	260°C
PEEK	-60°C	250°C
FEP	-200°C	200°C
SILICON	-40°C	180°C
ETFE	-185°C	150°C
PVC	-30°C	105°C
XLPE	-50°C	90°C
HDPE	-50°C	80°C
LDPE	-50°C	70°C

CONDUCTOR

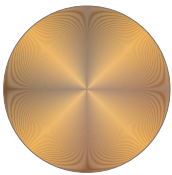

Solid

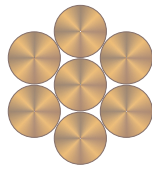

Stranded

The center component of any cable is the conductor which carries the signal or power through that cable. For signal & power transmission copper is the most commonly used conductor.

Type of Conductors

Copper conductors

Annealed Bare Copper(ABC), Tinned Plated Copper(TPC), Nickel Plated Copper(NPC), Silver Plated Copper(SPC)

Thermocouple conductors

- Thermocouple grade conductors(TC)
- Extension grade conductors(EX)
- Compensating grade conductors (C)

Other conductors

Pure Nickel Conductors (Ni) etc.

SCREENING

Screening is applied for magnetic and electrical protection. Generally two types of Screening are available :

- Aluminum Foil Type :- Screening is done by helically applied aluminum foil with 100 % coverage.
- Mesh Braided Type :- Screening is done by Copper wire (Bare Copper, Tinned Copper, Nickel Plated Copper, Silver Plated Copper). It is in mesh braided form with 70 % to 95% coverage area.

INNER SHEATH

PVC, Silicon, Teflon, Polyamide, Fibre Glass, Alumina Fibre etc. (as listed in insulation)

MECHANICAL PROTECTION

- G.I. Armouring (Round wire / Flat strip as per IS 3975:99)
- SS Braiding (More Flexible)

OUTER SHEATH

PVC, Silicon, Teflon, Polyamide, Fiber Glass, Alumina Fibre etc. (as listed in insulation).



CML No. - 8400077612



CABLES FOR TEMPERATURE SENSORS & INSTRUMENTATION

THERMOCOUPLE CABLES

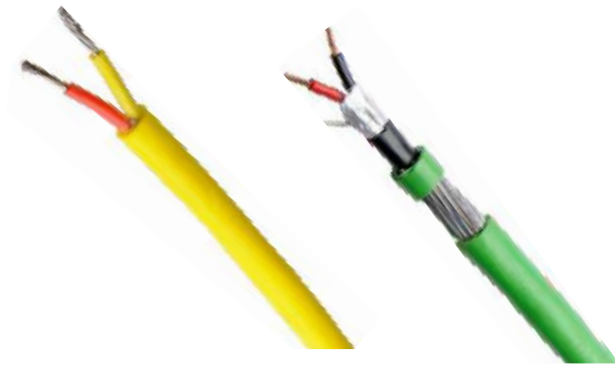

Thermocouple Cables are used to measure the temperature directly. Extension & Compensating wires are only used to extend a thermocouple signal from a sensor to instrument for readings.

Technical Specification

Construction	: Single or Multi pair
Voltage Grade	: Up to 1.1 KV
Conductor	: TC, EX, C (as per below table)
Type of Conductor	: K, T, J, E, N, R, S, B, D, C
Conductor Size	: AWG 12 to AWG 32
Conductor Stranding	: Solid or Multi strand
Core Insulation	: PVC, PTFE, FEP, PFA, Silicon, Polyamide, Fiber Glass, Ceramic Fiber etc.
Screening	: Aluminum Foil type/Mesh Braided type
Inner/Outer Sheath	: PVC, Teflon, Polyamide, Fiber Glass, Ceramic Fiber etc.
Armouring	: G.I. Armouring/SS Braiding
Color Code	: As per below table
Standards	: ANSI MC 96.1, IEC 584.3, IS 8784

T/C TYPE	CONDUCTOR		CONDUCTOR COMBINATIONS		COLOR CODE		TOLERANCE CLASS AS PER IEC 584.3		CABLE TEMP. RANGE °C
	EXTENSION CABLE	COMPENSATING CABLE	+LEG	-LEG	IEC 5843:1989	ANSI/MC96.1	CLASS 1	CLASS 2	
K			CHROMEL	ALUMEL			±1.5°C or 0.4% of T	±2.5°C or 0.75% of T	0°C TO +1100°C
	JK		CHROMEL	ALUMEL			±1.5°C	±2.5°C	-25°C TO +200°C
		KA	IRON	CONSTANTAN			-	±2.5°C	0°C TO +150°C
		KB	COPPER	CONSTANTAN			-	±2.5°C	0°C TO +100°C
T			COPPER	CONSTANTAN			±0.5°C or 0.4% of T	±1.0°C or 0.75% of T	-185°C TO +300°C
	TK		COPPER	CONSTANTAN			±0.5°C	±1.0°C	-25°C TO +100°C
J			IRON	CONSTANTAN			±1.5°C or 0.4% of T	±2.5°C or 0.75% of T	+20°C TO +700°C
	JK		IRON	CONSTANTAN			±1.5°C	±2.5°C	-25°C TO +200°C
N			NICROSIL	NISIL			±1.5°C or 0.4% of T	±2.5°C or 0.75% of T	0°C TO +1100°C
	NA		NICROSIL	NISIL			±1.5°C	±2.5°C	-25°C TO +200°C
E			CHROMEL	CONSTANTAN			±1.5°C or 0.4% of T	±2.5°C or 0.75% of T	0°C TO +800°C
	EA		CHROMEL	CONSTANTAN			±1.5°C	±2.5°C	-25°C TO +200°C
R		RA	COPPER	COPPER LOW VALUE NICKEL			-	±2.5°C	0°C TO +100°C
		RB	COPPER	COPPER NICKEL MO			-	±5.0°C	0°C TO +200°C
S		SA	COPPER	COPPER LOW VALUE NICKEL			-	±2.5°C	0°C TO +100°C
		SB	COPPER	COPPER NICKEL MO			-	±5.0°C	0°C TO +200°C
B		BC	COPPER	COPPER			-	-	0°C TO +100°C
D		DC	ALLOY 203*	ALLOY 225*			-	±4.5°C	0°C TO +100°C
C		CC	ALLOY 405*	ALLOY 426*			-	±4.4°C	0°C TO +100°C

INSTRUMENTATION SIGNAL CABLES



Instrumentation Signal Cables minimize noise and signal interference, delivering clean signals in harsh environments and general manufacturing operations. These cables are designed for use in communication and instrumentation.

Technical Specification

Construction	: Single Pair / Multi Pair
Voltage Grade	: Upto 1.1 KV
Conductor	: ABC, NPC, TPC, SPC, Ni
Conductor Size	: 0.50, 0.75, 1.0, 1.5, 2.5 Sq.mm or as per requirement
Conductor Stranding	: Solid or Multi strand
Core Insulation	: PVC, PTFE, FEP, PFA, Silicon, Polyamide, Fiber Glass, Ceramic Fiber etc.
Screening	: Aluminum Foil type/Mesh Braided type
Inner/Outer Sheath	: PVC, Teflon, Polyamide, Fiber Glass, Ceramic Fiber etc.
Armouring	: G.I. Armouring/SS Braiding
Standards	: As per BS 5308 Part 1 and Part 2, IS 8130, IEC 60228, JSS 51038



TECHNICAL DATA FOR PVC INSTRUMENTATION CABLE					
Conductor Size mm ²	Max. Conductor Resistance at 20°C ohm/Km	Max. Capacitance between Conductor nf/Km	Max. Capacitance between Conductor to screen nf/Km	Inductance mH/Km	L/R Ratio µH/Ohm
0.5	39.0	250	400	<1	<25
0.75	26.0	250	400	<1	<25
1.0	19.5	250	400	<1	<25
1.5	13.3	250	400	<1	<40
2.5	7.98	250	400	<1	<40

CABLES FOR HIGH TEMPERATURE & OTHERS

LV CONTROL & POWER CABLES

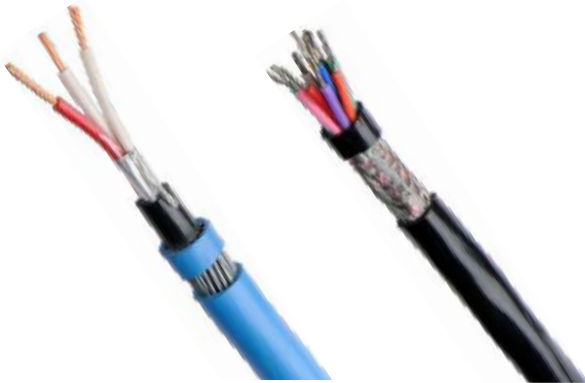

Tempsens provides Control & Power cable up to 1.1 KV voltage grade with variety of insulations.

Technical Specification

Construction	: 2, 3, 4, 5, 7, 12 or multiple cores
Voltage Grade	: Up to 1.1 KV
Conductor	: ABC, TPC, NPC, SPC, Ni
Conductor Size	: 0.50, 0.75, 1.0, 1.5, 2.5 Sq mm or as per customer requirement
Conductor Stranding	: Solid or Multistrand
Core Insulation	: PVC, PTFE, FEP, PFA, Silicon, Polyamide, Fiber Glass, Ceramic Fiber etc.
Screening	: Aluminum Foil type/Mesh Braided type
Inner/Outer Sheath	: PVC, Teflon, Polyamide, Fiber Glass, Ceramic Fiber etc.
Armouring	: G.I. Armouring/SS Braiding
Standards	: As per IS 1554, IEC 60502, IEC 60227, JSS 51038, IS 8130:84



PVC LEAD WIRES

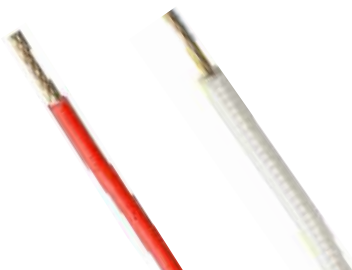

Tempsens provide wide range of Lead wire or Hook up wires up from temperature -260 °C to extreme high temperature 1200 °C with insulation PVC, PTFE, FEP, PEEK, Silicon, Glass Fiber, Ceramic Fiber etc.



HEAT RESISTANCE CABLES



Tempsens provides Heat resistance cables with maximum 800°C temperature withstanding.

Technical Specification

Construction	: 2, 3, 4, 5, 7, 12 or multiple cores
Voltage Grade	: Up to 1.1 KV Grade
Conductor	: ABC, TPC, NPC, SPC, Ni
Conductor Size	: 1.5, 2.5, 4.0, 6.0, 10.0, 16.0, 25.0, 35.0 Sq mm or as per customer specifications
Conductor Stranding	: Multistrand as per IS 8130:84
Core Insulation	: PTFE, FEP, PFA, Silicon, Fiber Glass, Ceramic Fiber etc.
Isolator	: Polyimide, Sintered PTFE Foil, Glass Mica Tape
Screening	: Aluminum Foil type/Mesh Braided type
Fire Barrier Tape	: Glass Mica Tape
Inner/Outer Sheath	: Teflon, Fiber Glass, Ceramic Fiber etc.
Armouring	: SS Braiding
Standard	: As per IS 8130:84, JSS 51038

OTHER SPECIAL CABLES

- Solar Photovoltaic Cables
- Linear Heat Sensing Cable
- Electron Beam Irradiator Cable
- RS-485 Cable
- Lance Cable
- Load Cell Cable
- Composite Cable
- Co-axial Cable
- Cat 5 & Cat 6 Cable



SLEEVES

Tempsens offer variety of sleeves suitable for wide temperature range with various insulation such as PTFE, FEP, Silicon, Fiber Glass, Stainless Steel wire, Polyamide & PVC.

Inner Diameter	: 0.50 mm to 10 mm
Voltage Grade	: Up to 10 KV
Color	: As per Customer requirement

MINERAL INSULATED METAL SHEATHED CABLES

Mineral insulated cables are designed for high-temperature applications and particularly strict requirements with regard to mechanical, chemical and electrical stability.

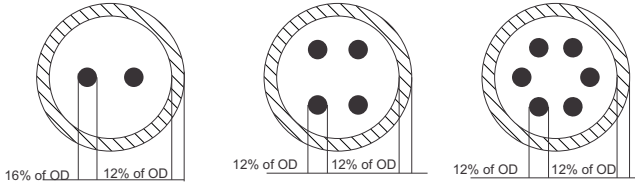

MINERAL INSULATED THERMOCOUPLE CABLES

Mineral insulated thermocouple cables have inner conductors of Thermocouple base material as per standard ASTM E 585/585M and ASTM E 839.

OD (MM)	TYPE	SHEATH	MGO GRADE	ACCURACY	
1.5	K - Simplex	304 - SS304L 310 - SS310 316 - SS316L 321 - SS321 600 - INCONEL 600	STANDARD (≥ 96% PURE)	CLASS 1	
2.0	KK - Duplex				
2.2	J - Simplex			CLASS 2	
3.0	JJ - Duplex				
4.5	E - Simplex			HIGH PURITY (≥ 99.4% PURE)	As per IEC 584-2 or ANSI MC 96.1
5.0	EE - Duplex				
6.0	N - Simplex				
8.0	NN - Duplex				
9.5	T - Simplex				
10.0	TT - Duplex				
12.7	R - Simplex	Note:- Diagonal Element Supplied Unless Specified			
	RR - Duplex				
	S - Simplex				
	SS - Duplex				

MINERAL INSULATED RTD CABLES

Mineral insulated cables for RTDs have inner conductors of copper, copper-nickel alloys, nickel etc. metals.

OD (MM)	NO. OF CONDUCTOR	CONDUCTOR MATERIAL	SHEATH	MGO GRADE
1.5	3 4 6 8	Ni - Nickel Cu - Copper NiCu - Constantan	304 - SS304L 316 - SS316L 321 - SS321 600 - INC 600	STANDARD (≥96% PURE)
2.0				
2.2				HIGH PURITY (≥ 99.4% PURE)
3.0				
4.5				
5.0				
4.8				
6.0				
8.0				
9.5				

OTHER SPECIAL TYPE OF MI CABLES

Mineral Insulated Heating Cables

Mineral Insulated Heating Cables are constructed with a solid resistor element embedded in highly compacted mineral insulation. MI cables are built to handle high temperature, high wattage applications.

Mineral Insulated Copper Cables (MI Power Cables)

Mineral Insulated Copper cable is used as an electric cable for critical areas of plant and follows standard of IEC/EN 60702 Part 1. It has two voltage grade 500V & 750V

Coaxial Cables/Triaxial Cables



Triaxial cable is a type of electrical cable similar to coaxial cable, but with the addition of an extra layer of insulation and a second conducting sheath. It provides greater bandwidth and rejection of interference than coaxial cable.

SPNDS



Self-Powered Neutron Detectors are in-core flux monitors in nuclear power reactors. The typical SPND is a coaxial cable consisting of an inner electrode (the emitter), surrounded by insulation and an outer electrode (the collector).

PROCESS HEATERS

TUBULAR HEATING ELEMENT

Tubular heating element consists of a resistant nickel chromium wire type 80/20 inserted into a protective metal tube (outer sheath) filled with high purity electro-melt Magnesium oxide (MgO). The assembly will be compacted by rolling/swaging process to ensure excellent heat transfer. Each edge of the sheathed component consists of a non-heating zone, where the electrical connection is made.

The electric heater is custom-made with a maximum length of 10500 mm, along with different diameters (8, 11, 12.50 & 16 mm).

ELECTRIC PROCESS HEATERS

Electric process heaters, popularly known as tubular heaters or electric heat exchangers are very similar to shell n tube heat exchangers, except that fact that heating energy is provided by the electric power flowing inside the tubes or heating elements.

Multiple numbers of mineral filled sheathed heating elements (tubular heating elements) will be installed into Baffle plate assembly n inserted inside the pressure vessel.

Material of construction : Steel (ERW and seamless)
Stainless as per ASTM Grade 304/304L/310/316/
316L/321 Alloys 600, 625, 640, 800, 825, 840

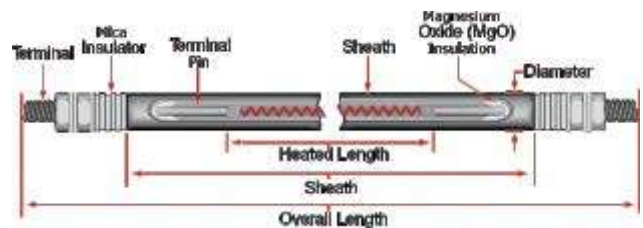

Once energized, the electric energy converted into heat n transferred to the fluid which will flow through the vessel from inlet nozzle to outlet.

Marathon designs complete thermal process n strength of the vessel using proven Software.

For accurate control n safety, each heater will be controlled by a dedicated Thyristor control Panel. Marathon is also expertise in designing n supplying such panels as a part of complete Process heating system.

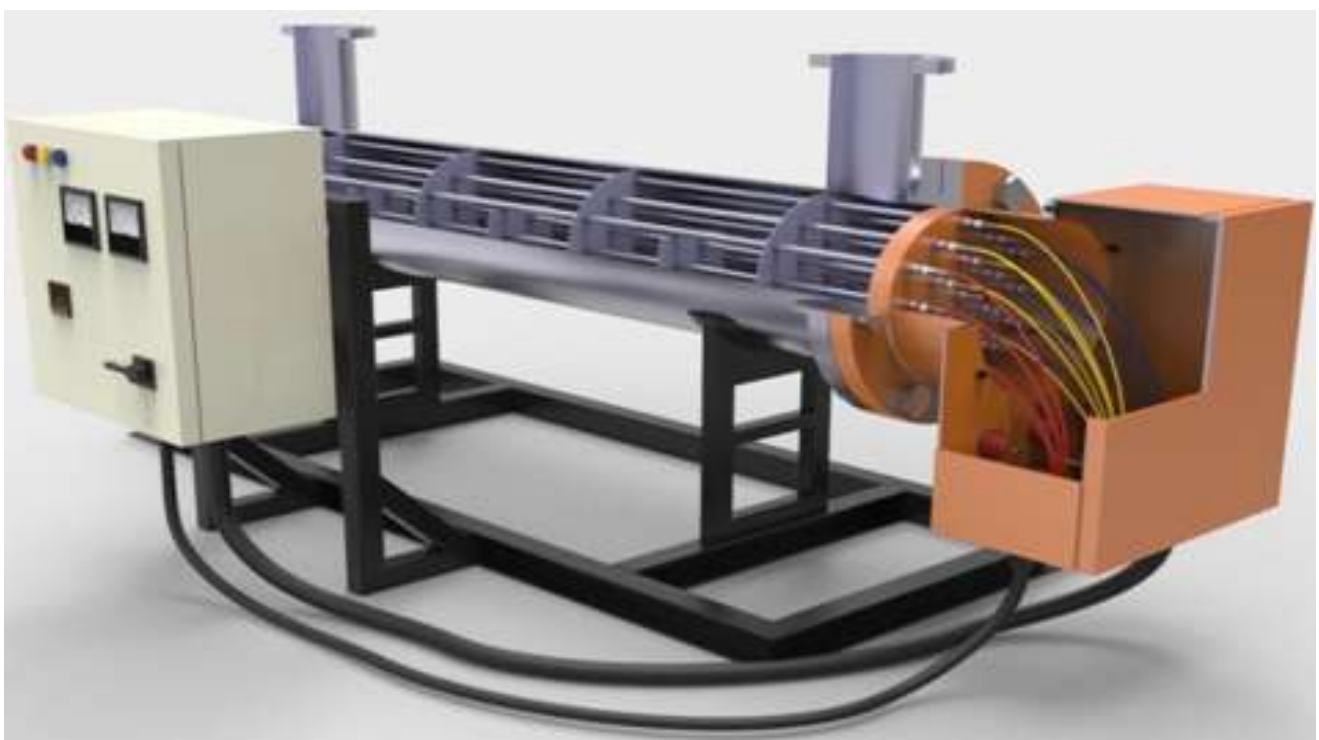

PROCESS HEATERS

HEATING ELEMENT TO HEATER FLANGE CONNECTION TYPES

The heating elements are connected to the heater flange by several methods. Below illustrated are few highly recommended methods. It is important to select most desired method of connection based on the design recommendation n process requirements.

Stand Pipe Construction with Brazing

This is the traditional way in which tubular heaters are passed through seamless pipes welded to the main heater flange n Terminal box end plate.

The pressure sealing is done by means of brazing or welding between Sleeve pipe n heating elements. This method is suitable for non-critical application with low pressure/low temperature applications.

This method is not recommended for the hazardous area applications.



Direct Welding of Heating Elements to Heater Flange

Direct seal welding of the heating elements to heater flange is achieved by specially designed joint in accordance to the ASME standards.

The highly precision weld carried out by qualified welders and evaluated by Third parties and consultants,

This is highly recommended for process heaters n hazardous gas heaters such Hydrogen etc.

Bite Coupling of Heating Elements to Heater Flange

This is the specialized design in which tubular heaters are connected to the heater flange by means of metallic ferrules n Nut assembly.

The pressure sealing is done by means of SS ferrule followed by Nuts tighten as per recommended torque.

This method is widely used for the heater constructions which in which hot work such as welding/brazing are not allowed.

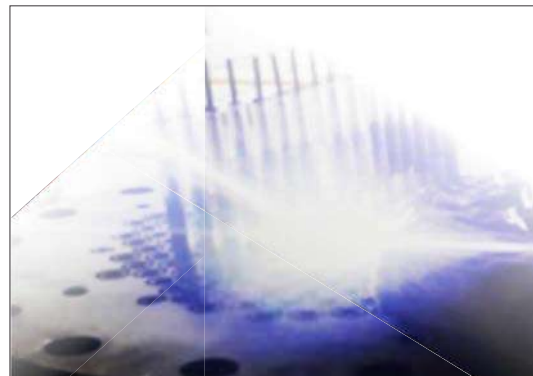

HEATER BUNDLE – CONSTRUCTION

A complete heater bundle design n construction is depends on various factors such as operation data, Process condition, Installation site condition, Standards n specifications, governing laws n regulations, certifications etc.

Marathon Heaters give high priority to ensure the proper design n selection of heater flange size and material by using proven design software's. The Results are also often verified n approved by in depended consultants, notified bodies etc.

In general, a Heater bundle consists of

- Heater flange
- Heating Elements
- Baffle Plates and Tie Rods assembly
- Terminal Enclosure
- Temperature Protection sensors



THERMAL IMAGERS

AST-TE-700

High Resolution Ultra Compact Online Thermal Imager

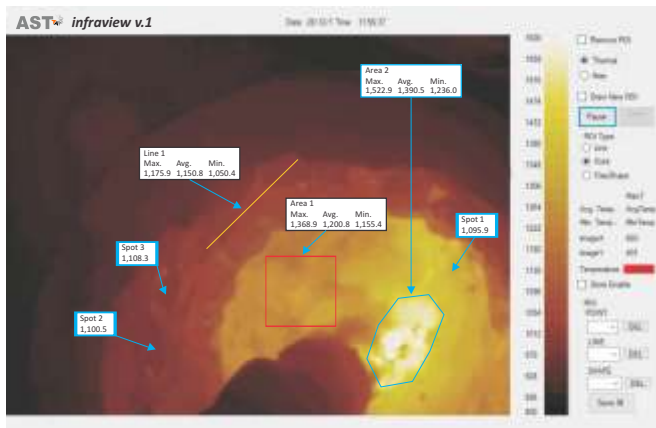

Software

- Configurable ROI's : point, line, free shape
- Histogram and isotherm visualization
- Hot and cold spot detection
- Color pallet scaling
- Trend charts and Alarm output
- Video and Image export
- Server client configuration

- High dynamic CMOS detector with upto 768 x 576 pixels resolution
- Thermal as well as Monochrome Video Display
- Fast thermal data acquisition in real time via Gigabit Ethernet/USB
- Configurable storage and replay temperature video
- Digital and analog input/output modules
- Software controlled parameter settings
- Multiple client PC configuration
- Infraview software
- Integration in customized system solution, including software adjustments
- Accessories : Cooling Jacket, Pinhole Lens Tube, Retraction Device
- Optics variants available

Temperature Range	700°C-1800°C
Spectral Range	0.85 - 1.1µm
Resolution	768x576 pixels
Frame Rate	25Hz
Analog Output	4 Channel Analog Current Output
Digital Input	4 Active-high, Buffered Inputs
Digital Output	4 Open Source, Mosfet Outputs

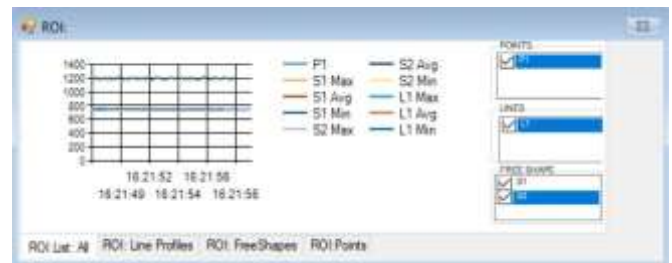

TI-160

Affordable High Resolution Portable Thermal Imager



- 3.5" TFT LCD
- Built in microphone to record 40 second voice annotation
- Multiple lenses option
- Automatic hot / cold / average spot recognition
- Intuitive and easy operation menu
- Multi function PC analysis software
- Alarm - voice and color

Temperature Range	-20°C~+350°C,-20°C~+600°C
Spectral Range	7.5~14µm
Resolution	160x120 pixels
Measurement Accuracy	±2°C/±2%(reading)
Emissivity	Adjustable from 0.01 to 1.0
Storage Type	Built-in flash card, 800 images
Connectivity	USB 2.0, Radiometric images, measurement data and voice are transferred to PC

FURNACE MONITORING CAMERA



Model	Specification
Klin Burning Zone	
TFV-750	Straight View Visual Camera
TE-750	Straight View Thermal Camera
Cooler	
TFV-750/OV	Elbow View Visual Camera
TE-750/OV	Elbow View Thermal Camera

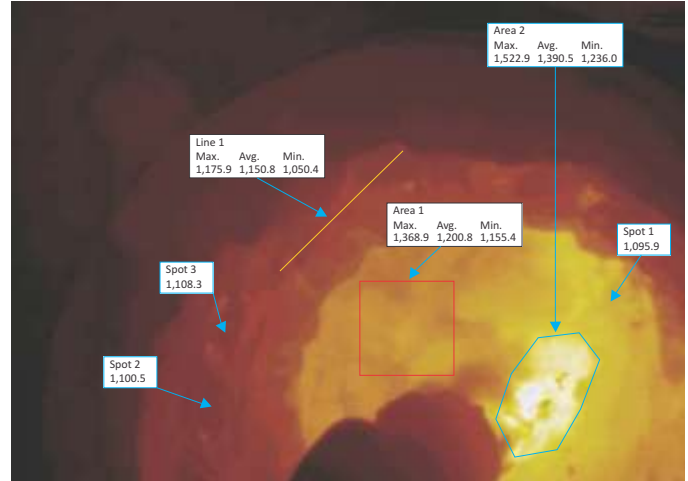

CCD Camera

Image sensor : 1/3" Super HD CCD
 TV Line : Black and White 650 lines
 Illumination : 0.005Lux@F2.0
 Image : Manual adjustable
 Video output : Composite 1 [Vp-p] 75 (Ω)
 Power : DC12V (±10%)

Thermal Camera

Image Sensor : HD CMOS Sensor
 Temperature Range : 700° C to 1800° C
 Accuracy : 0.3% of measure value + 1°
 Resolution : 768 x 576 pixels
 Frame rate : 25 Hz
 Spectral Range : 0.85 to 1.1µm
 Connectivity : Ethernet/USB

Pinhole lens

Lens length : 820 mm & 1100 mm
 Angle of view : Straight view HxVxD 67°, 56°, 81°
 Elbow view 45°, 60°
 Mount : CS
 Focus : Manual Adjustable
 Length : 820 mm



Straight View



Angle View

Features

- Water cooled lens tube, Vortex cooled camera chamber
- Auto retraction and shutter
- Pneumatic cylinder
- Air Purged
- Control panel with pneumatic system
- Software Infraview for Thermal camera
- Input/Output module

Infraview Software (For thermal Camera)

- Configurable ROI's : point, line, free shape
- Histogram and isotherm visualization
- Hot and cold spot detection
- Color pallet scaling
- Trend charts
- Alarm output
- Video and Image export
- Server client configuration

TEMPERATURE CALIBRATION EQUIPMENTS

CALIBRATION

Tempens manufactures equipments for temperature calibration. The test sensors are calibrated against master sensors in a stable temperature source.

The various temperature source for covering temperature sensor calibration are as under.

LIQUID BATHS

	Temperature Range	Stability	Calibration Volume (mm)	Medium
CALsys -80/50	-80 to 50°C	0.05°C	100(L) x 130(W) x 200(D)	Methanol
CALsys -40/50	-40 to 50°C	0.05°C	90(L) x 90(W) x 150(D)	Methanol
CALsys -35/50	-35 to 50°C	0.05°C	220(L) x 180(W) x 250(D)	Methanol
CALsys -35/200	-35 to 200°C	0.01°C	157(L) x 142(W) x 127(D)	Silicon Oil
CALsys 120SP	0 to 120°C	0.1°C	Dia 24 x 100(L), 3 x 6 hole	Silicon Oil
CALsys 250	50 to 250°C	0.1°C	Dia 90 x 140 (D)	Silicon Oil
CALsys 300SP (Large Volume)	50 to 250°C	0.1°C	100(L) x 150(W) x 200(D)	Silicon Oil



DRY BLOCK/FURNACES

	Temperature Range	Stability	Calibration Volume (mm)
CALsys -196/-80	-196 to -80°C	0.1°C	Dia 24 x 300 (L) (2holes of 6.5, 2holes of 8.5)
CALsys -15/110 (Peltier Dry Block)	-15 to 110°C	0.1°C	Dia 24 x 120 (L), (3 holes of 6.0) 115 (D)
CALsys 650	50 to 650°C	0.1°C	Dia 32 x 150 (L), 4 holes of 6.5 x 120 (D)
CALsys FB (Fluidised Bath)	50 to 650°C	1.0°C	Dia 150 x 385 (D)
CALsys 1200	250 to 1200°C	0.5°C	Dia 37 x 215 (L), (2x6 & 2x8 holes) of 160 (D)
CALsys 1200L	300 to 1200°C	0.5°C	Dia 37 x 240 (L), (2x6 & 2x8 holes) of 160 (D)
CALsys 12003Z (3- Zone Furnace)	300 to 1200°C	0.4°C	Dia 37 x 240 (L), (2x6 & 2x8 holes) of 160 (D)
CALsys 1500L	500 to 1500°C	1.0°C	Dia 37 x 245 (L), (2X6 & 2X8 holes) of 140 (D)
CALsys 1700L	500 to 1700°C	2.0°C	Dia 37 x 240 (L) (2x6 & 2x8 holes) of 225 (D)

MASTER SENSORS

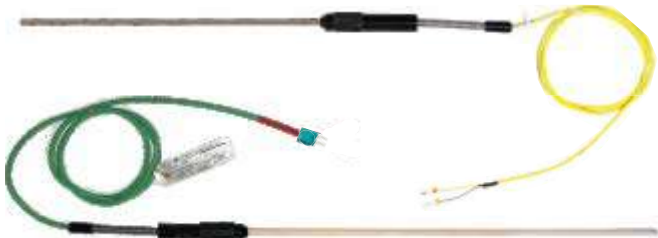

Accurate Master Temperature Sensors in various configuration are available with Calibration certificate from our NABL Accredited Lab.

- **SSPRT** : PT100/PT25, Temperature range 0 to 661°C
 - **RTD** : PT100
- Accuracy : 1/10, 1/5, 1/3, 1/2 DIN, Class A
 Sheath Material : SS316, Inconel, Quartz
- **THERMOCOUPLE** : K/N/R/S
- Accuracy : Special, Class 1, with option cold junction compensation
 Sheath Material : Inconel/Ceramic (KER710-C 799)

BLACK BODY



Black bodies are reference sources used for testing infrared systems. They are required in industry for calibration of pyrometers, infrared line scanners or cameras.

Tempens offers black body temperature source with large temperature range, high stability & high emissivity.

	Temp. Range (°C)	Stability	Emissivity	Calibration Volume (mm)
CALsys 500BB	50 - 500	1.0°C	0.95	Dia - 100 mm
CALsys 1200BB	300 -1200	1.0°C	0.99	37±1mm dia & 140mm depth
CALsys 1500BB	500 - 1500	1.0°C	0.99	37±1mm dia & 140mm depth
CALsys 1700BB	500 - 1700	2.0°C	0.97	29 mm, 235 mm depth
Fast Cal 1200	300 - 1200	1.0°C	0.99	15 (H) x 80 (L), SS Strip
Fast Cal 2600	700 -2600	3.0°C	0.99	15 (H) x 100 (L), Graphite Strip

FURNACES

LM STANDARD FURNACES (MAX. 1200°C)



Model	Max. Temp (°C)	Dimension internal HxWxD (mm)	Volume (Liters)	Max Power (kW)	Heating element
LM 112	1200	100x100x150	1.5	2	Kanthal A1
LM 312	1200	90x175x300	5	2.8	Kanthal A1
LM 412	1200	150x175x320	7.5	3.2	Kanthal A1
LM 512	1200	230x200x400	18.5	8	Kanthal A1

VMK (MAX. 1800°C)



Model	Max. Temp (°C)	Dimension internal HxWxD (mm)	Volume (Liters)	Max Power (kW)	Heating element
VMK 1400	1400	150x170x270	6.8	4	Sic
VMK 1600	1600	150x170x270	6.8	4	MOSi ₂
VMK 1700	1700	110x150x240	4.0	4	MOSi ₂
VMK 1800	1800	110x150x240	4.0	4	MOSi ₂

OTHER SPECIAL FURNACES



Microwave Furnace



Gas Atmosphere Furnace

- Microwave Furnace.
- Induction Heating Furnace.
- Hybrid-dual Mode Furnace (microwave & resistance heating).
- Special vacuum & gas atmosphere furnace.

BOTTOM LOADING FURNACES



Model	Maximum Temperature (°C)	Internal Dimension* (H X W X D) (mm)	Heating Element
BLF - 1200	1200	120X120X120	Kanthal A1
BLF - 1500	1500	120X120X120	Silicon Carbide
BLF - 1800	1800	120X120X120	MoSi ₂

*Custom size on request

TEMPERATURE TRANSMITTERS



- Head Mounted Transmitter
- Din Rail Mounted Transmitter
- Field Mounted Transmitter
- Din Rain Mounted Transmitter with isolation

SERVICES

CALIBRATION SERVICES

Tempens Calibration Center is an independent unit of Tempens instruments (I) Pvt. Ltd, having laboratories at Udaipur, Vadodara & Bangalore. It is accredited for wide range of temperature calibration services.

It is the only private sector Laboratory in the country with accredited Fixed Point Temperature calibration Facilities. The lab has highly stable calibration furnaces, measuring instruments and accurate master sensors traceable to National and International Standards.



C-0321
Udaipur
Lab

C-1155
Vadodara
Lab

C-1226
Bangalore
Lab

IN HOUSE CALIBRATION FACILITY

Quality Measured/ Instruments	Temperature Range	Calibration & Measurement Capability
Contact Type RTD, Thermocouples Thermometers	-196°C	0.06°C
	-80 to -38°C	0.06°C
	-38°C to 0°C	0.05°C
	>0°C to 140°C	0.04°C
	>140°C to 250°C	0.04°C
	>250°C to 650°C	0.12°C
Non Contact Type Pyrometer	>650°C to 1200°C	1.60°C
	>1200°C to 1600°C	2.60°C
	0°C to 100°C	1.5°C
	>100°C to 500°C	2.4°C
	>500°C to 1500°C	2.5°C
	>1500°C to 1700°C	3.3°C
	>1700°C to 2700°C	4.0°C

ON SITE CALIBRATION FACILITY

Quality Measured/ Instruments	Temperature Range	Calibration & Measurement Capability
Contact type RTD, Thermocouples Thermometers	-25°C to 0°C	0.07°C
	>0°C to 140°C	0.04°C
	>140°C to 250°C	0.09°C
	>250°C to 650°C	0.12°C
	>650°C to 1200°C	2.3°C
Non Contact Type Pyrometer	0°C to 100°C	1.50°C
	>100°C to 500°C	2.40°C
	>500°C to 1200°C	2.5°C
Multipoint Position Calibration of Chamber, Oven, Furnaces (Thermal Mapping(TUS))	-80°C to 200°C	5.5°C
	>200°C to 1200°C	3.4°C

FIXED POINT CALIBRATION FACILITIES

Quality Measured/ Instruments	Temperature Range	Calibration & Measurement Capability
Calibration of SPRT/PRTS/ thermocouple etc.	Triple Point of Water (0.01°C)	0.0038°C
	Melting Point of Gallium (29.7646°C)	0.0065°C
	Freezing Point of Tin (231.928°C)	0.0065°C
	Freezing Point of Zinc (419.527°C)	0.0071°C
	Freezing Point of Aluminum (660.323°C)	0.0075°C

The calibration center functions as per ISO 17025 / NABL standards. Calibration of contact type sensors can be made in temperature range of -196°C to 1600°C and Calibration of non contact type sensors can be made in temperature range 0°C to 2700°C. Further the laboratory is accredited for onsite temperature calibration.

The lab offer both at Lab & On-Site Calibration of Furnace/Bath from -80°C to 1600°C and Black Body Calibration from 50°C to 1700°C.

Furnace/Chamber Calibration (TUS) with multiple sensors from -80°C to 1200°C is also in the scope of the lab.

THERMOGRAPHY SERVICES

Tempens provide thermography services for various industries. Thermography enables to monitor the thermal efficiency of critical process systems that rely on heat transfer of retention.

This is one of the most powerful, fast and one of the most cost-effective condition monitoring technique that has wide application in any industry in detecting incipient faults, if left unattended, would not only lead to loss of productivity and quality but also increase operations and maintenance costs.

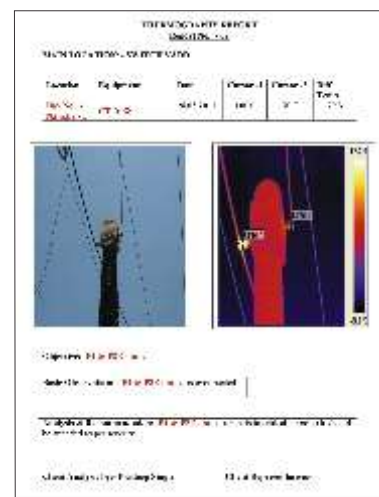

Sample Thermography Report

CERTIFICATES



THERMAL & CABLE SOLUTIONS



www.tempsens.com

www.thermowellworld.com | www.temperaturecalibration.in | www.glassthermocouples.com | www.compensatingcables.net | www.marathonheater.in

INDIA

Tempsens Instruments (I) Pvt. Ltd. U# I
 B-188A, Road No.5, M.I.A.,
 Udaipur-313003 (Rajasthan) INDIA
 Ph.: +91-294-3057700 to 800
 Fax.: +91-294-3057750
 Email: info@tempsens.com

Tempsens Instruments (I) Pvt. Ltd. U# II
 A-190, Road No.5, M.I.A.,
 Udaipur-313003 (Rajasthan) INDIA
 Ph.: +91-294-3052900
 Fax.: +91-294-3052950
 Email: info@tempsens.com

GERMANY

Tempsens Instruments GmbH
 Loehestrasse 37,
 53773 Hennef, GERMANY
 Ph.: +49 2242 8703-22,
 Fax: +49-2242-8703-20,
 Email: basant@tempsens.com
 hmueller@tempsens.de

INDONESIA

Pt. Tempsens Asia Jaya
 Jln. Jembatan Tiga Raya No.6
 Jakarta 14440, INDONESIA
 Hp.: (+62)877 8080 4433
 Telp.: (+62) 21 666 00050
 Fax: (+62) 21 661 6789
 Email: support@tempsens-asia.com

